

iPad 360

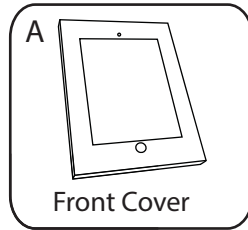

Front Cover

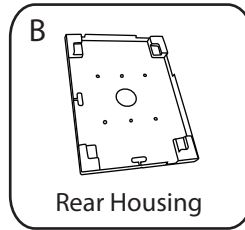

Rear Housing

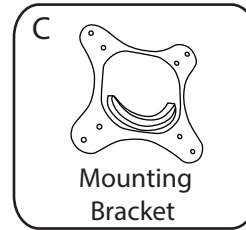

Mounting
Bracket

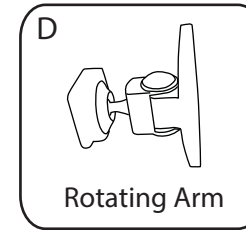

Rotating Arm

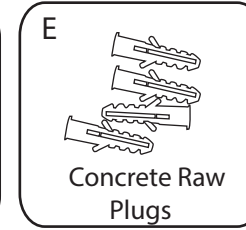

Concrete Raw
Plugs

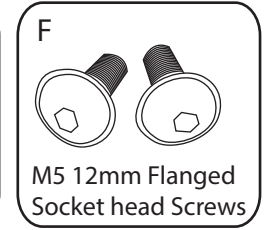

M5 12mm Flanged
Socket head
Screws

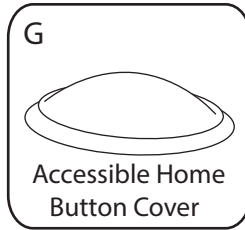

Accessible Home
Button Cover

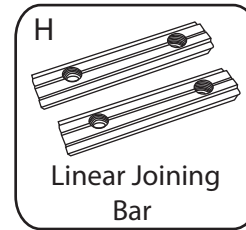

Linear Joining
Bar

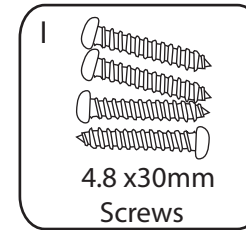

4.8 x30mm
Screws

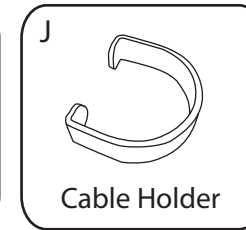

Cable Holder



M4 x 16mm Socket
Head Cap
Screws

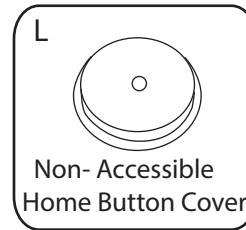

Non- Accessible
Home Button Cover

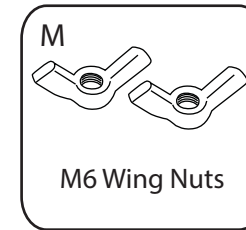

M6 Wing Nuts

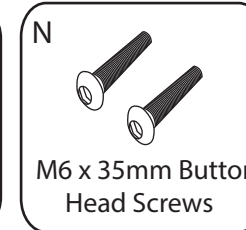

M6 x 35mm Button
Head
Screws

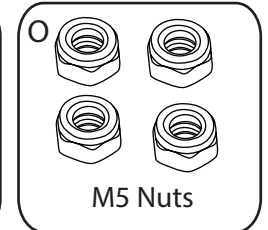

M5 Nuts

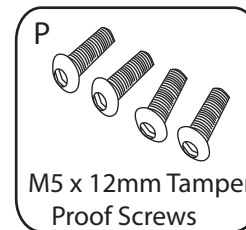

M5 x 12mm Tamper
Proof
Screws

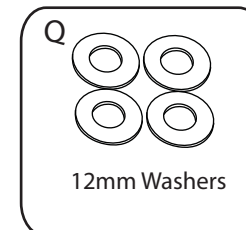

12mm Washers

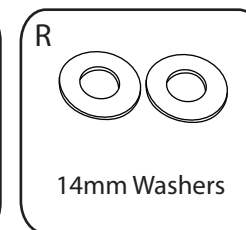

14mm Washers



M5 x 8mm Tamper
Proof
Screws

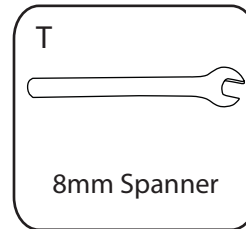

8mm Spanner

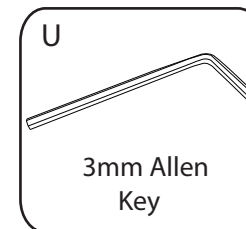

3mm Allen
Key

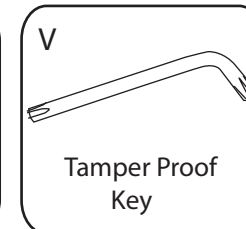

Tamper Proof
Key

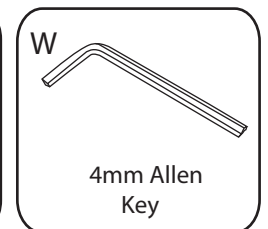

4mm Allen
Key



iPad 360

Swivel Bracket Assembly

Parts required D,C,K,U,B,P,O,Q,T,V

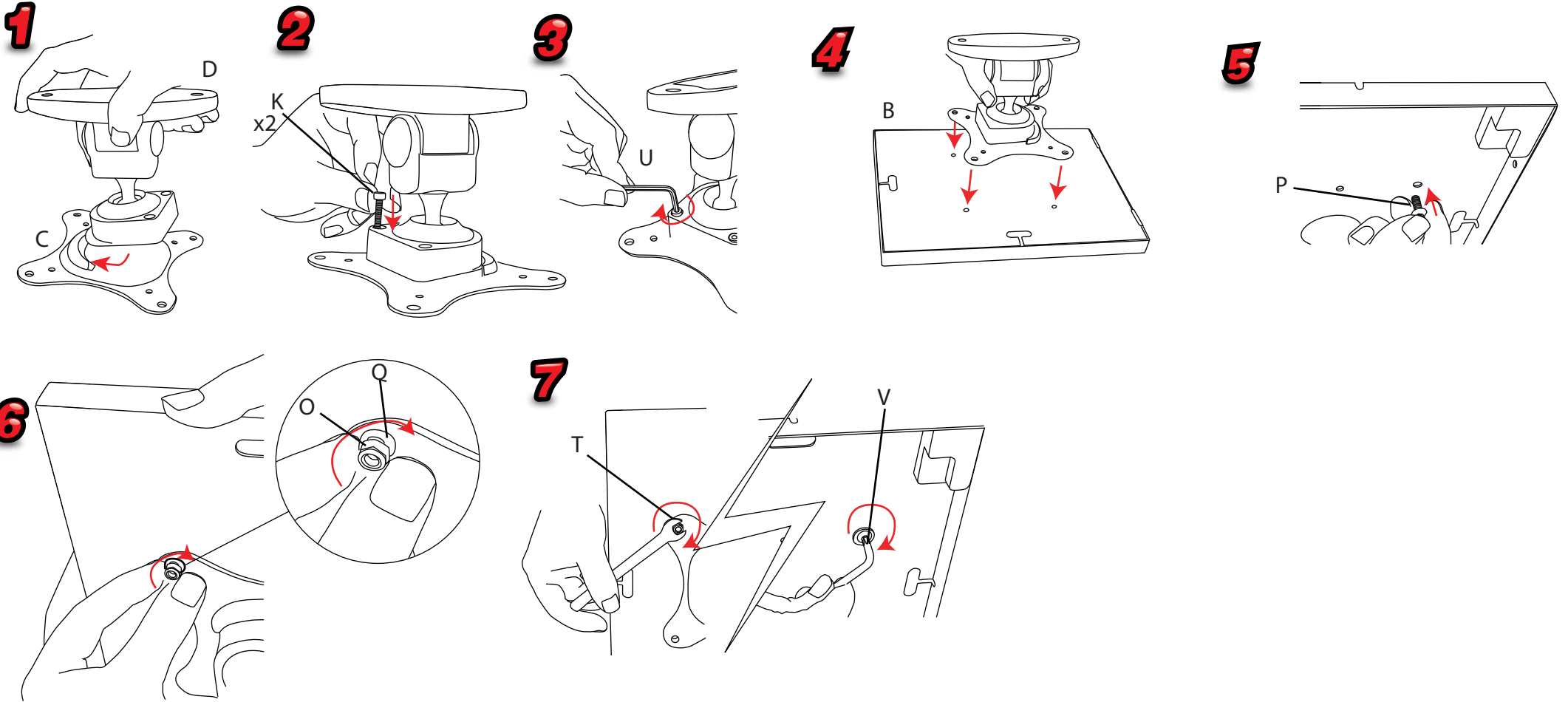

iPad 360

iPad housing Assembly
Parts required B,L,G,A,S,V

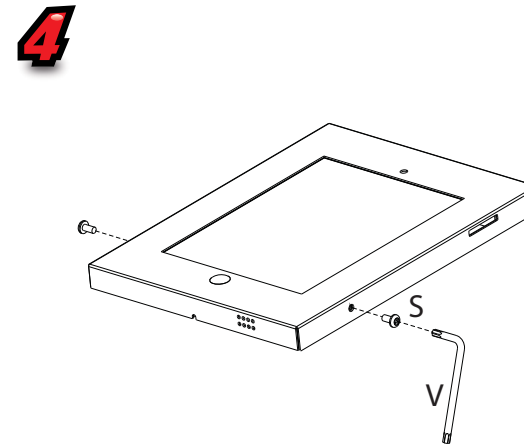
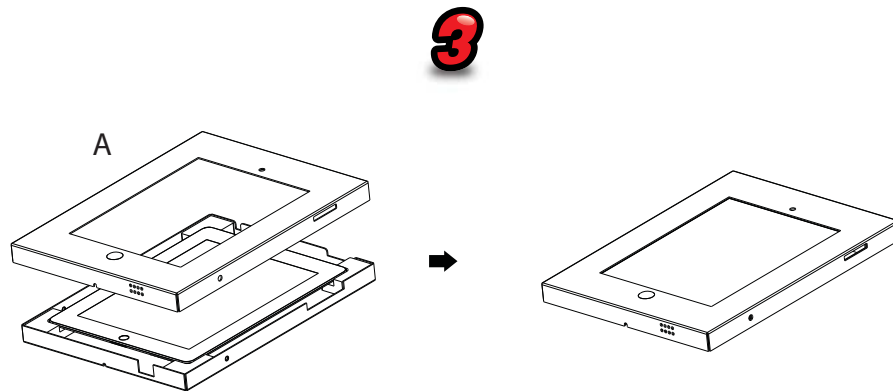
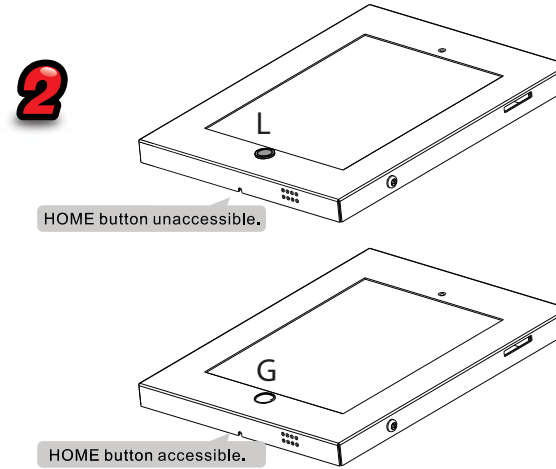
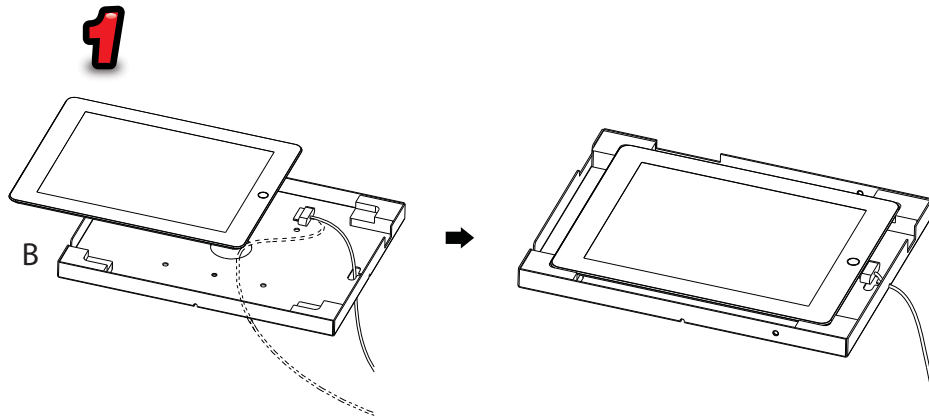

iPad 360

Desktop Mount Assembly
Parts required N,R,W,M

Desktop Mount Hole Dimensions

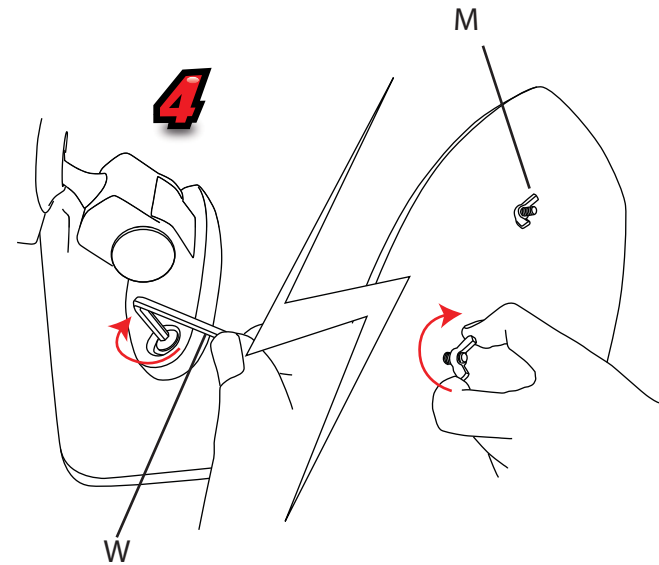
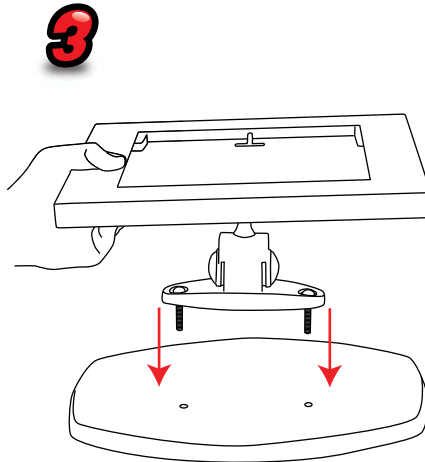
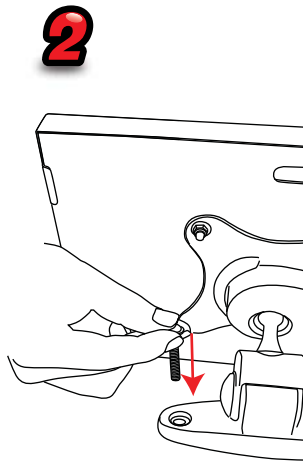
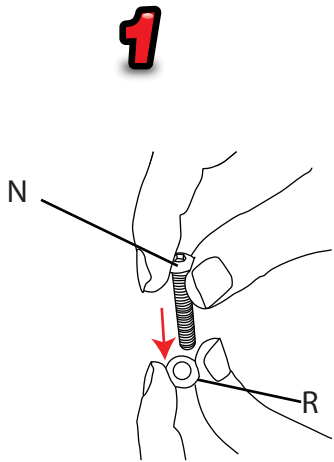
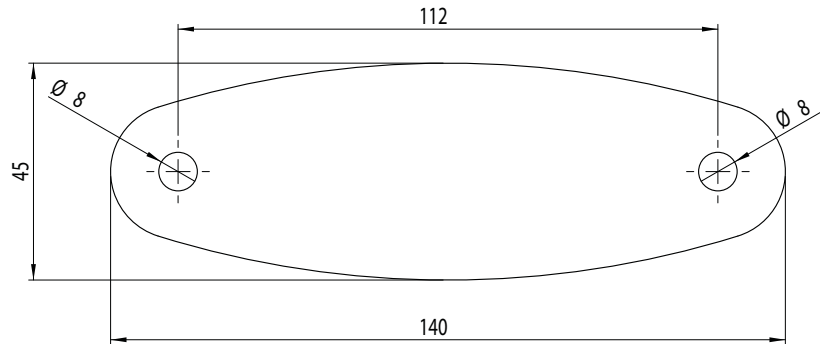

iPad 360

Linear Post Mount Assembly
Parts required F,H,U,B,

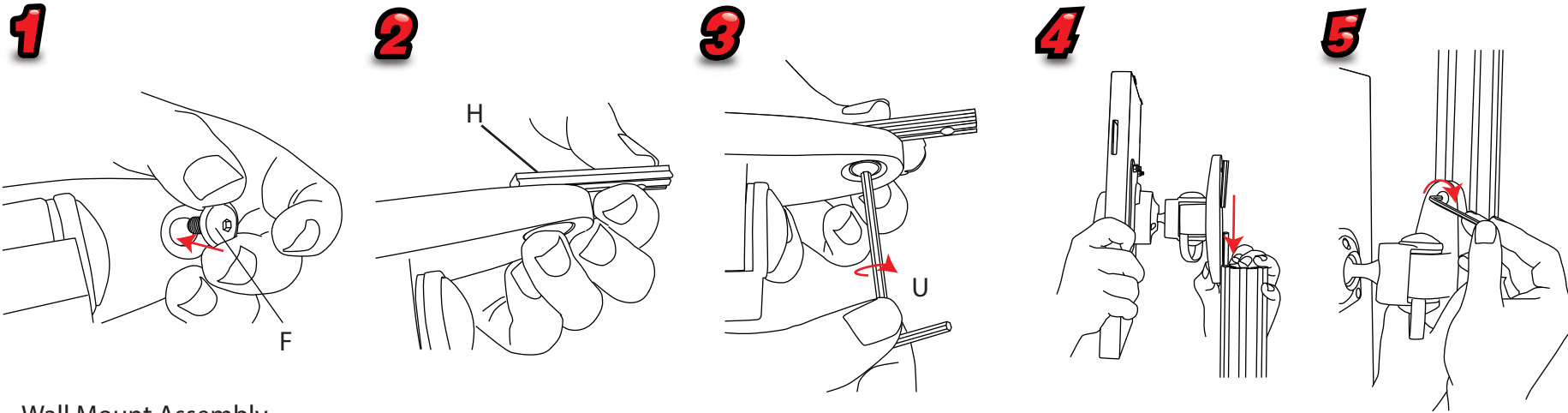

Wall Mount Assembly
Parts required B,E,I

